

# **Aerobic Biodegradation of Oily Wastes**

## **A Field Guidance Book For Federal On-scene Coordinators**

Version 1.0, October 2003



**U.S. Environmental Protection Agency**  
**Region 6 South Central**  
**Response and Prevention Branch**

# EXECUTIVE SUMMARY

This field guidance document was produced specifically as an aid for Federal On-scene Coordinators (FOSC) in U.S. Environmental Protection Agency (EPA) Region 6. It is intentionally limited in scope to best serve the requirements of the Region 6 Oil Program. Typically, Oil Program projects are completed quickly and efficiently and often do not require more than half a year to complete. Because of the nature of the Oil program, only aerobic land treatment was considered. Ongoing consultation with state and local officials during the land treatment process is assumed and essential to success.

The level of detail provided in this field guide may be less than required for each project, but is sufficient to adequately diagnose technical problems should they occur. The writers of this field guide are aware that the users come from a variety of backgrounds and possess a wide range of field experience. In an attempt to develop a tool that may be used easily by both experienced and less-experienced users, minimum information is provided and an extensive bibliography section including web sites is included. Once the users have read and become familiar with the field guide, small shaded boxes or tables adjacent to a “pumpjack” icon help in locating key points throughout the document.

This field guide consists of three parts complemented by appendices. The first part provides information to help evaluate the nature of the environment where land treatment is considered and a summary of the existing regulations and policies in Region 6. The second part provides an overview of the factors to be considered and studied when determining if landfarming is a viable option and also discusses key points in the process design. The last part focuses on operation issues and provides useful tools and information for efficient management of aerobic land treatments.

A checklist was also developed to help the FOSC evaluate existing field conditions, evaluate feasibility of the technology, and monitor bioremediation progress. The items covered by the checklist are electronically linked to the appropriate section in the document.

The principal author, Ben Banipal, is a registered Professional Engineer who currently serves EPA Region 6 in the Solid Waste Program. Ben has provided consultation to the Region 6 Oil Program on many occasions to ensure good land treatment of hydrocarbon-contaminated wastes. Ben produced this document in conjunction with many experienced FOSCs, with Team Leader Jim Mullins on temporary detail to the Region 6 Oil Program, and with the Superfund Technical Assessment and Response Team (START-2) contractor. This document was submitted for peer-review to several experts (EPA Emergency Response Team (ERT), EPA Headquarters, and University of Tulsa) in the field of bioremediation.

# TABLE OF CONTENTS

<b>EXECUTIVE SUMMARY</b>	<b>2</b>
<b>CHECKLIST FOR LANDFARMING ASSESSMENT</b>	<b>6</b>
<b>PART I</b>	<b>7</b>
<b>INTRODUCTION</b>	<b>7</b>
<b>GLOSSARY</b>	<b>10</b>
<b>SITE CHARACTERIZATION</b>	<b>12</b>
Waste Classification	12
Chemical Analysis for Biodegradation Suitability	12
Soil Evaluation	14
Physical Properties	14
Chemical Properties	15
Biological Properties	16
<b>CRUDE OIL CHEMISTRY</b>	<b>18</b>
<b>SITE-SPECIFIC CLEANUP STANDARD - APPLICABLE FEDERAL AND STATE REGULATIONS</b>	<b>20</b>
Federal Regulations	20
State Regulations and Policies	21
State Regulations and Policies in the State of Texas	21
State Regulations and Policies in the State of Louisiana	22
State Regulations and Policies in the State of Oklahoma	22
State Regulations and Policies in the State of New Mexico	23
State Regulations and Policies in the State of Arkansas	23
<b>PART II</b>	<b>24</b>
<b>REMEDY SELECTION</b>	<b>24</b>
<b>ECONOMIC/COST BENEFIT ANALYSIS</b>	<b>25</b>
<b>AEROBIC BIODEGRADATION REMEDY SCREENING/ SELECTION STUDIES</b>	<b>26</b>
Biodegradation Treatment Design	27
In Situ Bioremediation Treatment	27
Ex Situ Bioremediation Treatment	28
Land Treatment Unit Site Evaluation and Selection	28
Land Treatment Unit Design and Construction	28

<b>PART III</b>	<b>30</b>
<b>LAND TREATMENT UNIT OPERATION</b>	<b>30</b>
<b>LTU LOADING RATES</b>	<b>30</b>
<b>BIODEGRADATION TREATMENT TIME</b>	<b>30</b>
<b>CONDUCTING AN EFFECTIVE BIODEGRADATION - MONITORING LTU PARAMETERS</b>	<b>31</b>
Soil Moisture Content	32
Soil Nutrients	33
Soil pH	34
Effect of Temperature	35
Oxygen Infiltration - Tilling	35
<b>LABORATORY METHODS FOR LTU SOIL PARAMETERS TESTING</b>	<b>35</b>
<b>MONITORING HYDROCARBON BIODEGRADATION</b>	<b>36</b>
Baseline Soil Sampling	36
Quality Assurance and Quality Control	36
Interim Soil Sampling	36
Cleanup Level Confirmation Soil Sampling	37
<b>SITE RESTORATION</b>	<b>37</b>
<b>BIBLIOGRAPHY</b>	<b>38</b>

## TABLES

TABLE 1-1 Suggested Chemical Analytical Methods for Contaminated Soil Characterization	13
TABLE 1-2 Soil Particle Size Classification	14
TABLE 1-3 Microbial analysis Methods	17
TABLE 1-4 Biodegradation Agents According To The NCP Product Schedule	18
TABLE 1-5 Crude Oil Distillation Fractions	19
TABLE 1-6 Risk assessment for evaluation of oil clean-up levels in New Mexico.	23
TABLE 1-7 Evaluation of clean-up action levels in New Mexico (mg/kg).	23
TABLE 2-1 Estimated cost of various treatment technologies (production only)	25
TABLE 3-1 Initial TPH Loading Rates	30
TABLE 3-2 Summary of Laboratory and Field Treatment Data (Sublette 2001)	31
TABLE 3-3. LTU Soil Characteristics for Effective Bioremediation Treatment	32
TABLE 3-4 Suggested Agricultural Inorganic Fertilizers	34
TABLE 3-5 Field methods to test LTU parameters.	37
TABLE C-1 Crude Oils Handled Near Cushing, Oklahoma	46
TABLE C-2 Typical Crude Oils Handled In Region 6	47

## FIGURES

FIGURE 1-1 Evaluation of landfarming as a remediation option for hydrocarbon-contaminated soils .....	9
FIGURE 1-2 Schematic representation of the relationship of the various forms of soil moisture to plants (Sublette, 2001) .....	15
FIGURE 2-1 Flow Diagram of Tiered Approach (EPA 540/2-91/013A) .....	26
FIGURE 2-2 Schematic of typical ex situ land treatment unit .....	29
FIGURE 3-1 Half-life degradation of diesel fuel and various types of crude oils as practiced by Chevron Texaco Company. (McMillen et al, May 2002).....	30
FIGURE 3-2 Factors Requiring Assessment During Biodegradation of Oily Wastes .....	32

## APPENDICES

<b>APPENDIX A - TYPICAL BIODEGRADATION WORK PLAN.....</b>	<b>40</b>
<b>APPENDIX B - USEFUL CONVERSION FACTORS.....</b>	<b>42</b>
<b>APPENDIX C - CRUDE OIL CHEMISTRY .....</b>	<b>44</b>
<b>APPENDIX D - LTU PARAMETER ANALYSIS METHODS.....</b>	<b>49</b>

## CHECKLIST FOR LANDFARMING ASSESSMENT

<b>Background information</b>				
✓ <a href="#">Is the source of the release controlled?</a>	<input type="checkbox"/> Yes		<input type="checkbox"/> No	
✓ <a href="#">Is the site stabilized?</a>	<input type="checkbox"/> Yes		<input type="checkbox"/> No	
<a href="#">Establish contamination levels</a>	[TPH]=	[Metals]=	[Other]=	
<a href="#">Acceptable contamination levels (federal and/or state)</a>				
✓ Are levels below acceptable state levels?	<input type="checkbox"/> Yes		<input type="checkbox"/> No	
✓ <a href="#">Are the following circumstances present?</a>	<input type="checkbox"/> Rocky land?	<input type="checkbox"/> Flood plains?	<input type="checkbox"/> High mineral deposits?	<input type="checkbox"/> [TPH]>8%
✓ <a href="#">What type of funding will be used?</a>	<input type="checkbox"/> CERCLA	<input type="checkbox"/> OPA	<input type="checkbox"/> Other	
<b>Evaluate soil properties</b>				
✓ <a href="#">Soil classification</a>	Sand <span style="display: inline-block; width: 150px; height: 10px; background-color: orange;"></span> Clay			
✓ <a href="#">Slope angle</a>	Preferred angle <5%		Measured	%
✓ <a href="#">Moisture</a>	Preferred concentration 50-70%		Measured	%
✓ <a href="#">pH</a>	Preferred 6-8 units		Measured	Units
✓ <a href="#">Salinity</a>	Preferred EC < 1dS/m		Measured	dS/m
✓ <a href="#">CEC</a>	Preferred 5-25 meq/100 g soil		Measured	Meq/100 g
✓ <a href="#">Metals content</a>	Above normal background		<input type="checkbox"/> Yes	<input type="checkbox"/> No
✓ <a href="#">Bacterial count</a>	Preferred range 10 <sup>5</sup> to 10 <sup>6</sup> bacteria per gram of soil		Measured	
✓ <a href="#">Need for more bugs?</a>	<input type="checkbox"/> Yes	See NCP	<input type="checkbox"/> No	
<b>Evaluate oil properties</b>				
✓ <a href="#">API gravity</a>	Measured		API < 20, bioremediation not favored	
✓ <a href="#">Sulfur content</a>	Measured			
<a href="#">Perform remedy screening</a>	Optimal reduction: 20-60% in 3-6 weeks		Reduction	%
			Time of study	weeks
<a href="#">Perform remedy selection</a>	Potential problems?			
✓ <a href="#">Contamination depth</a>	<input type="checkbox"/> <1 foot	In-situ	<input type="checkbox"/> > 1 foot	Ex-situ
<a href="#">Design LTU</a>	<input type="checkbox"/> Berms?	<input type="checkbox"/> Liner?	<input type="checkbox"/> Irrigation?	<input type="checkbox"/> Other
<a href="#">LTU Temperature</a>	Measured	°C	Temperature <8°C does not favor bioremediation	
<a href="#">TPH Loading</a>	Applied as function of temperature			%
<b>Evaluate LTU variables</b>				
✓ <a href="#">Nutrient (C:N:P:K)</a>	Preferred 100:5:1:1		:	:
✓ <a href="#">Temperature</a>	Preferred 75-95°F			°F
✓ <a href="#">Moisture</a>	Preferred 50-70%			%
✓ <a href="#">pH</a>	Preferred 6-8 units			units
<a href="#">Optimize LTU variables for duration of treatment</a>				
<b><a href="#">Final TPH concentration</a></b>	<b>Measured</b>			<b>%</b>

# PART I

## INTRODUCTION

The objective of this field guide is to provide guidance to Federal On-scene Coordinators (FOSC) in selecting and conducting land aerobic biodegradation of oil-contaminated wastes from inland oil spills, leaking/unplugged oil wells, abandoned oil refinery sites, pipeline ruptures, and/or tank failures. The United States consumes approximately 1.6 million barrels of oil every day, and roughly 45% of the United States' crude oil production occurs in EPA Region 6 states (Arkansas, Louisiana, New Mexico, Oklahoma and Texas). Despite recent technology advances, accidental spills of crude oil and its refined products occur frequently during extraction, storage, transportation, distribution, and refining process. Besides these oil handling activities, the number of mature oil fields is growing in Region 6 and so are abandoned oil wells, which may be either unplugged or plugged improperly. Irrespective of its origin, when a spill occurs, it has the potential to endanger human health and the environment and may directly contaminate air, surrounding soil, surface water and groundwater. Because oil spills occur despite all precautions, we must have countermeasures and remediation options to deal with this challenge in the most effective, efficient, and economical manner.

Figure 1-1 summarizes some of the steps that must be followed while evaluating and selecting the appropriate remediation option. The first step when contamination occurs is to ensure that the source is controlled; if that is the case, mechanical collection can occur and the site may be stabilized. If the source is still releasing contaminants, an emergency action must be taken prior to the beginning of cleanup procedures. Once the site is stabilized, the residual soil levels must be established and compared against federal and state policies/regulations to determine if further cleanup actions are required. In the event that further remediation is needed, various technologies should be evaluated to determine which is most cost and time efficient. If bioremediation, or landfarming, is the favored option, a soil and land assessment/acceptability must be performed. If the area for potential remediation is rocky, has flood plains, contains high mineral deposits or high concentrations of total petroleum hydrocarbons (TPH) or metals, landfarming is not the best option and another technology must be selected. Finally, prior to performing remedy screening, remedy selection, and land treatment unit design, ensure that the proper funding mechanism is selected. A typical biodegradation workplan can be found in Appendix A.

The scope of this field guide is limited to aerobic biodegradation, also known as landfarming or land treatment, of oil-contaminated soils. It is arranged in a logical way to facilitate the decision-making process for selecting biodegradation as a remediation option. It is divided into three parts:

**Part I** deals with assessing the site, characterizing the waste, and establishing the origin of waste so that the appropriate funding mechanism is applied to clean up the spill. Biological, chemical, and physical classification of waste is described to assess biodegradation feasibility. Finally, state requirements are reviewed to establish site-specific cleanup levels at the beginning of the land farming activities.



**Part II** elaborates on the remedy selection streamlining process along with cost benefit analysis.



**Part III** describes the biodegradation implementation and optimization of operations and maintenance of a land treatment unit (LTU) to achieve cleanup standards in a timely manner. Finally, the restoration process for the site to pre-spill conditions is presented. Figure 1-1 provides a typical flow diagram of an Oil Pollution Act biodegradation assessment.

*The Principle of Infallibility states: "It is probably not unscientific to suggest that somewhere or other some organism exists which can, under suitable conditions, oxidize any substance which is theoretically capable of being oxidized." E.F. Gale (1952)*



**FIGURE 1-1 Evaluation of landfarming as a remediation option for hydrocarbon-contaminated soils**

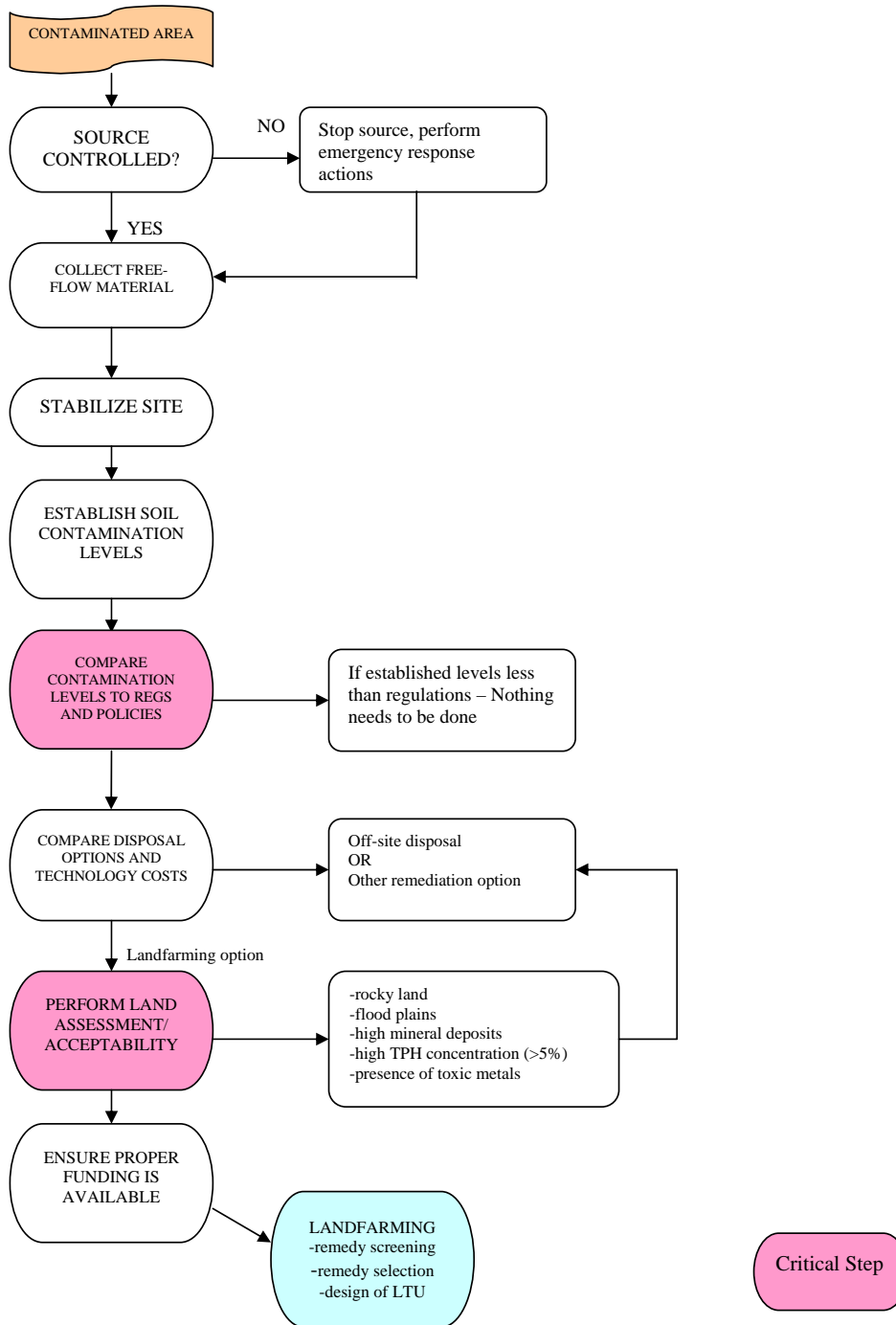

# GLOSSARY

**Aerobic:** In the presence of, or requiring, oxygen.

**Anaerobic:** Relating to a process that occurs with little or no oxygen present.

**API Gravity:** The industry standard method of expressing specific gravity of crude oils. Higher API gravities mean lower specific gravity and lighter oils.

**Biodegradation:** The breakdown or transformation of a chemical substance or substances by microorganisms using the substance as a carbon and/or energy source.

**Boiling Point:** The temperature at which the vapor pressure of a given liquid reaches atmospheric pressure (and thus starts to boil).

**Cation Exchange:** The interchange between a cation in solution and another cation in the boundary layer between the solution and surface of negatively charged material such as clay or organic matter.

**Cation Exchange Capacity (CEC):** The sum of the exchangeable bases plus total soil acidity at a specific pH, usually 7.0 or 8.0. When acidity is expressed as salt extractable acidity, the cation exchange capacity is called the effective cation exchange capacity (ECEC), because this is considered to be the CEC of the exchanger at the native pH value. It is usually expressed in centimoles of charge per kilogram of exchanger (cmol/kg) or millimoles of charge per kilogram of exchanger.

**CERCLA:** Comprehensive Environmental Response, Compensation, and Liability Act. This law created a tax on the chemical and petroleum industries and provided broad federal authority to respond directly to releases or threatened releases of hazardous substances that may endanger public health or the environment.

**Clean Water Act:** The Clean Water Act establishes the basic structure for regulating discharges of pollutants into the waters of the United States. It gives EPA the authority to implement pollution control programs such as setting wastewater standards for industry. The Clean Water Act also continued requirements to set water quality standards for all contaminants in surface waters and makes it unlawful for any person to discharge any pollutant from a point source into navigable waters, unless a permit was obtained under its provisions.

**Degradation:** The breakdown or transformation of a compound into byproducts and/or end products.

**Field Capacity:** In situ (field water capacity): The water content, on a mass or volume basis, remaining in a soil 2 or 3 days after having been wetted with water and after free drainage is negligible.

**Heterotrophic bacteria:** Bacteria that utilize organic carbon as a source of energy.

**Infiltration Rate:** The time required for water at a given depth to soak into the ground.

**Loading Rate:** Amount of material that can be absorbed per volume of soil.

**LTU:** Land Treatment Unit, physically delimited area where contaminated land is treated to remove/minimize contaminants and where parameters such as moisture, pH, salinity, temperature and nutrient content can be controlled.

**Osmotic Potential:** Expressed as a negative value (or zero), indicates the ability of the soil to dissolve salts and organic molecules. The reduction of soil water osmotic potential is caused by the presence of dissolved solutes.

**OPA:** Oil Pollution Act of 1990. It addresses oil pollution and establishes liability for the discharge and substantial threat of a discharge of oil to U.S. navigable waters and shorelines.

**Oven Dry:** The weight of a soil after all water has been removed by heating in an oven.

**Permeability:** Capability of the soil to allow water or air movement through it. The quality of the soil that enables water to move downward through the profile, measured as the number of inches per hour that water moves downward through the saturated soil.

**Metabolism:** The sum of all of the enzyme-catalyzed reactions in living cells that transform organic molecules into simpler compounds used in biosynthesis of cellular components or in extraction of energy used in cellular processes.

**Microorganism:** A living organism too small to be seen with the naked eye; includes bacteria, fungi, protozoans, microscopic algae, and viruses.

**NCP:** National Contingency Plan (also called the National Oil and Hazardous Substances Pollution Contingency Plan). Provides a comprehensive system of accident reporting, spill containment, and cleanup, and established response headquarters (National Response Team and Regional Response Teams).

**Saturation:** The maximum amount of solute that can be dissolved or absorbed under given conditions.

**TPH:** Total Petroleum Hydrocarbons. The total measurable amount of petroleum-based hydrocarbons present in a medium as determined by gravimetric or chromatographic means.

**Wilting Point:** The largest water content of a soil at which indicator plants, growing in that soil, wilt and fail to recover when placed in a humid chamber. Often estimated by the water content at -1.5 MPa soil matrix potential.

## SITE CHARACTERIZATION

This section describes the basics of site characterization and assessment. For a detailed removal site assessment, refer to EPA Region 3 Removal Site Assessment Guidebook. After reviewing site history and conducting a preliminary survey, the extent and type of contamination must be assessed in detail. The nature of spilled material, its volume, and the extent of contamination specific to the particular event are some of the variables required to fully conduct the assessment and to evaluate and choose the most cost-effective removal option.

### Waste Classification

A detailed waste classification and a determination of the origin of the waste assist the FOSC in planning the removal activities and in utilizing the appropriate funding instrument. A thorough “paper review” and site history must be conducted to establish Oil Pollution Act (OPA) of 1990 or Comprehensive Environmental Response and Liability Act (CERCLA) authority. Typically, an oil refinery waste consists of both OPA and CERCLA wastes (oily pits from crude oil, refined products, tank bottoms, asbestos, corrosives, small laboratory containers, wastewater treatment wastes, Resource Conservation and Recovery Act (RCRA)-listed wastes), and a careful waste classification is required to use appropriate funding to remediate the site. Reference to *Crude Oil and Natural Gas Exploration and Production Wastes; Exemption from RCRA Subtitle C Regulations, EPA 530-K-95-003, May 1995*, may be useful in evaluating the site and selecting proper funding mechanisms.



Crude oil and petroleum products consist of mixtures of thousands of compounds and are very complex. To determine appropriate response actions, the properties of these compounds must be understood. For more information on crude oil properties and components, refer to Appendix C of this document.

### Chemical Analysis for Biodegradation Suitability

Total petroleum hydrocarbons (TPH)-contaminated soils amenable to biodegradation vary in concentration and waste type. Soils containing high (> 80 g/kg or 8%) TPH concentrations are not amenable to land treatment. However, concentrations of petroleum product up to 25% by weight of soil could be treated by mixing with less contaminated soils to lower the concentrations to desirable ranges. TPH concentrations less than 8% are readily treatable. The final TPH levels attainable vary based on waste streams, site conditions, and the component properties of the waste oil. For example, if the oil is highly weathered and contains very little biodegradable hydrocarbons remaining, then it is not amenable to bioremediation.

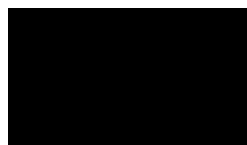

Long chain and high molecular weight hydrocarbons of generally 20 carbon atoms or higher are more resistant to biodegradation but still biodegradable. Petroleum products consisting of complex asphaltenes, polar resins, and tar are not candidates for land treatment.

Representative samples of the land treatment unit (LTU) soil/waste should be collected and analyzed for, but not necessarily limited to, volatile organic compounds (VOCs), polynuclear aromatic hydrocarbons (PAH), total petroleum hydrocarbons (TPH), metals, and naturally occurring radioactive material (NORM). Table 1-1 suggests chemical analytical methods.

**TABLE 1-1 Suggested Chemical Analytical Methods for Contaminated Soil Characterization**

Analyte	Method	Target Compound	Pro/Con/Remark
TPH	EPA 418.1 (infrared)	Mineral oil measurement.	Inexpensive and quick screening tool. Cannot be used to identify oil.
	EPA 413.1 (gravimetric)	Gravimetric oil and grease.	
	Modified EPA SW846 8015B (GC/FID)	Total petroleum hydrocarbons & extractable hydrocarbons.	Hydrocarbon quantification, basic product identification.
	Modified EPA SW846 8015B (GC/FID)	C <sub>8</sub> to C <sub>40</sub> normal and branched alkanes.	To determine weathering state and level of biodegradation.
VOCs	Modified EPA SW846 8260B (GC/MS)	C <sub>5</sub> to C <sub>12</sub> analysis, gasoline additives.	Light product identification and degree of weathering.
Semi-volatiles	Modified EPA SW846 8270C (GC/MS)	8270C: semi-volatile compounds including parent and alkyl-substituted PAHs	Quantification of all semi-volatile compounds, fingerprint information, and long-term weathering; expensive.
	For PAH only, EPA SW846 8310 (HPLC)	8310: PAH	
Metals	Total EPA SW846 6010B	6010B: antimony, arsenic, barium, beryllium, cadmium, chromium, cobalt, copper, lead, lithium, nickel, selenium, silver, thallium, vanadium, and zinc.	Quantification of all metals contained in soil; cost depends on the number of metals that are analyzed.
	Mercury SW846 7470A (liquids) and 7471A (solids)	7470A & 7471A for mercury.	
	TCLP using extraction method 1311	To test metals that may be a hazard to the environment.	Provides information on "stability" of metals in soil.
NORM	Direct-reading instrument to measure effective dose (Sievert)	Provides assessment of low levels of radiation.	Direct reading method: quick, inexpensive, does not identify the nature of the isotope.
	Laboratory analysis to measure concentration or activity (Bequerel)	Provides assessment of low levels of radiation	Laboratory analysis: expensive, provides accurate quantitative isotope characterization.

To obtain SW846 methods, go to <http://www.epa.gov/epaoswer/hazwaste/test/main.htm>

Deleted: Section Break (Continuous).

## Soil Evaluation

Soil is the medium in which treatment will take place; therefore, it is of utmost importance to evaluate its properties. Soil is heterogeneous in nature and varies widely in physical, chemical, and biological properties. The characteristics important in the design and operation of a land treatment site include the slope, the soil classification (texture and permeability), the soil moisture content, pH, the cation exchange capacity (CEC), and salinity. If the initial soil properties are not ideal for the biodegradation of hydrocarbons, they can be optimized (see Part III).

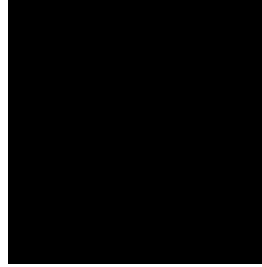

## Physical Properties

A gently sloped terrain can help minimize earthwork, but slopes in excess of 5% are not recommended for land treatment facilities due to erosion problems and less than ideal surface drainage and run-off control capabilities. However, physical manipulation of the land may produce the appropriate slope incline.

A survey should be performed to classify the indigenous soil present on-site. A soil engineer or scientist may be consulted to perform soil classification. Soil particle analysis allows the identification of soil type and is inexpensive to conduct. A general soil classification scheme based on the U.S. Standard Sieve Analysis provides the Unified Soil Classification System (USCS) and is presented in Table 1-2.

**TABLE 1-2 Soil Particle Size Classification**

Soil Type		U.S. Sieve No.	Particle Size
Coarse-Grained	Gravelly Soil	Retained on No. 4	Larger than 4.75 mm
	Sandy Soil	No. 4 through No. 200	From 4.75 to 0.075 mm
Fine-Grained	Clayey Soil	Passing No. 200	Smaller than 0.075 mm
	Silty Soil	Passing No. 200	Smaller than 0.075 mm

If more than 50% of the soil is retained on No. 200 sieve, it is considered coarse-grained soil; otherwise, it will be fine-grained soil. Coarse-grained soils permit rapid infiltration of liquids and allow good aeration; they are considered to be very permeable. However, they may not control containment of waste and nutrients added to the soil as well as fine-grained soils, which would be considered impermeable. The oxygen (air) transfer rate and substrate availability are greater in coarse-grained soils than in fine-grained soils due to more air pore space and thus favor aerobic conditions desirable for biodegradation. Coarse-grained soils are also more desirable since they can be more favorably loaded with hydrocarbons. Fine-grained soils should be loaded more lightly in a shallower depth and will generally require more tilling for equivalent performance.



Another important variable that should be assessed during soil characterization is its moisture content, or the amount of water it can hold. Saturation, field capacity, wilting point, and oven dry are the four conditions that will help evaluate the irrigation needs of the treated soil. Saturation is undesirable, as it decreases oxygen availability and limits site access for nutrient application and tilling. About 50 to

70% of soil field capacity is ideal for microbial activities, and adequate drainage can help manage that range. Soil field capacity could easily be determined in the field by saturating the soil, draining it for 24 hours under gravity, then by weighing and oven drying at 105 °C to attain a constant weight.

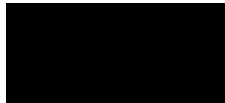

$$\text{Weight of drained soil} - \text{weight of oven dry soil} = \text{weight of water in the soil at field capacity}$$

$$\% \text{ of water in soil at field capacity} = (\text{weight of water/dry weight of soil}) \times 100$$

Infiltration rate should also be assessed because application of a liquid at a rate greater than that rate will result in flooding and erosion. This variable is also used to calculate the water balance of the LTU area. Figure 1-2 provides a schematic of soil moisture relationship. At water levels greater than the field capacity, water may accumulate and result in flooding and erosion. Below the wilting point, the soil becomes too dry, slowing down microbial activities.

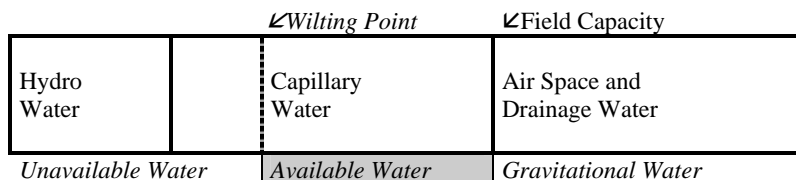

**FIGURE 1-2 Schematic representation of the relationship of the various forms of soil moisture to plants (Sublette, 2001)**

### Chemical Properties

Soil is a heterogeneous medium and so are its chemical composition and reactivity. The soil may be acidic or basic, may have high or low nutrients, and may exhibit a different exchange capacity at different locations in the same area.

The pH of a soil and its cation exchange capacity (CEC) are important variables to monitor in order to optimize the degradation process. The chemical reactions that occur in soil proceed at different rates depending upon the pH of the soil. The pH should be maintained near neutral, around 7.0 units, for optimum nutrient availability but a pH range between 6 and 8 units is acceptable. Reagents such as lime, aluminum sulfate, and sulfur can be used to adjust the pH. Caution should be used to avoid “over correction” of pH, and further consultation may be used to help calculate optimum quantities. The CEC value is an indication of the capacity of the soil to retain metallic ions (CEC value is usually obtained through laboratory testing) and is measured in milliequivalents per one hundred grams of dry soil (meq/100g). A CEC value greater than 25 is an indication that the soil contains more nutrients and has a high clay content, whereas values less than 5 indicate a sandy soil with little ion retention. Most metals found in oily wastes are not readily soluble in water: however, variations of pH may change that property and when treating land where the soil has a low CEC, care must be taken to manage subsurface of metal ions. With proper pH management, metals remain immobilized in the treatment zone even with low CEC values.



Soil salinity results from accumulation of neutral soluble salts (mainly due to neutral salts of sodium, calcium, magnesium, and potassium) in the upper soil horizon following capillary movement of the water, which evaporates and leaves the crystalline form of the salt, which is often indicated by a white crust.

Elevated concentrations of the salts can be lethal to many microorganisms. Assessing the feasibility of biodegradation in relation to salinity is achieved by measuring electrical conductivity (EC) in dS/m, which is a general measure of soil salinity. At EC values above 1 dS/m, biological growth is hindered, and values above 6 dS/m indicate most likely a sterile soil.



Finally, the soil should be analyzed for heavy metal content since a high metal concentration could be toxic to microbial survival and growth. Metals do not get remediated by native soil bacteria. Therefore, if the heavy metal concentrations in soil exceed the acceptable residual levels as determined by federal and state regulations (<http://www.cleanuplevels.com/>), bioremediation is not a viable option.

### Biological Properties

The biological action in the soil accounts for approximately 80% of waste degradation in soil (refer to Hazardous Waste Land Treatment, SW-874, 1980), the remainder being due to evaporation, photo-oxidation, and solubilization in water. This is true as long as environmental conditions such as the presence of oxygen, adequate moisture, moderate temperatures, neutral pH, low to moderate salinity, and excess nutrients, are present to allow bacteria can to grow exponentially. The impact of these environmental conditions is discussed in detail in Part III.

The main two approaches of bioremediation include bioaugmentation and biostimulation. In the first approach, oil-degrading bacteria are added to the existing bacterial population in the soil to increase the rate of oil consumption.

Biostimulation is the addition of nutrients and optimization of environmental conditions to improve the biodegradation efficiency of indigenous bacteria. Hydrocarbon degraders are ubiquitous, so it is seldom if ever appropriate to add an exogenous source of microorganisms to enhance the native populations. Populations of hydrocarbon degraders exposed to hydrocarbons increase rapidly when given adequate aeration, moisture, favorable pH, and excess nutrients. This has been demonstrated repeatedly in the literature.

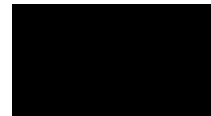

Generally, hydrocarbon-degrading bacteria are found in the range of  $10^5$  to  $10^6$  bacteria per gram of soil under no oil spill conditions, and when exposed to crude oil, that number increases to  $10^6$  to  $10^8$  per gram of soil. A detailed description of soil microbiology is beyond the scope of this field guide, but typically, one gram of rich agricultural soil contains  $2.5 \times 10^9$  bacteria (heterotrophic count),  $5 \times 10^5$  fungi,  $5 \times 10^4$  algae, and  $3 \times 10^4$  protozoa. (Sublette, 2001) Soil samples should be analyzed for enumeration of both heterotrophic and hydrocarbon-utilizing bacteria population to verify population densities. The population of microorganisms could be assessed in soil by plate count, most probable number technique, phospholipid fatty acid (PLFA) analysis, or denaturing gradient gel electrophoresis (DGGE). (Zhu et al,



2001) The following table provides a summary of these methods. It should be noted that there is no single species of bacteria that can metabolize all the components of crude oil.

**TABLE 1-3 Microbial analysis Methods**

<b>Plate Count</b>	<b>Most Probable Number</b>	<b>Phospholipids Fatty Acid (PLFA) Analysis</b>	<b>Denaturing Gradient Gel Electrophoresis (DGGE)</b>
Provides a count of colonies formed on specific solid media.	Uses liquid media and hydrocarbons as the carbon source to evaluate microbial growth.	Can provide a quantitative assessment of viable biomass, community composition, and nutritional stature.	Identifies species distribution.
Inexpensive.	Simple field method, slightly more labor intensive and time consuming.	Requires specialized knowledge and expensive instrumentation.	Requires specialized knowledge and expensive instrumentation.
Does not differentiate between types of bacteria.	Specific to hydrocarbon-metabolizing bacteria.	Can be used to analyze culture-independent bacteria but does not identify species.	Species-specific, can provide fingerprint of bacterial community.

Although published results indicate that commercial bioaugmentation products do not enhance biodegradation rates nor improve the degree of hydrocarbon remediation, there are rare circumstances when bioaugmentation may be warranted. If the environmental conditions are not favorable to indigenous bacteria, such as, for example, in brine soils where the salinity is too high to support normal bacterial populations, a commercial culture highly tolerant of hostile salty environments and able to degrade hydrocarbons may be added.

EPA has compiled a list of bioremediation agents as part of the NCP product schedule, which is required by the CWA, the OPA and the NCP (EPA 2000). A current list of the agents in the NCP schedule is provided in Table 1-4. A product can be listed only when its safety and effectiveness have been demonstrated under the conditions of a test protocol developed by EPA. (NETAC, 1993) However, listing does not mean that the product is recommended or Government-certified for use on an oil spill. The EPA efficacy test protocol uses laboratory shake flasks to compare the degradation of artificially weathered crude oil in natural seawater with and without a bioremediation product. Biodegradation is proven with a full gas chromatography/mass spectrometry (GC/MS) analysis that shows the product degrades both alkanes and aromatics.

**TABLE 1-4 Biodegradation Agents According To The NCP Product Schedule**

(Adopted from U.S. EPA 2000, June 2003)

<http://www.epa.gov/oilspill/ncp/>

<b>TYPE</b>	<b>NAME OF TRADEMARK</b>	<b>MANUFACTURER</b>
BIOLOGICAL ADDITIVES (Microbial Culture or Enzyme Additives)	BET BIOPETRO	BioEnviro Tech Tomball, TX
	MICRO-BLAZE	Verde Environmental, Inc. Houston, TX
	OPPENHEIMER FORMULA	Oppenheimer Biotechnology, Inc. Austin, TX
	PRISTINE SEA II	Marine System Baton Rouge, LA
	STEP ONE (aka B&S Industrial)	B & S Research, Inc. Embarrass, MN
	SYSTEM E.T.20	Quantum Environmental Technology, Inc. La Jolla, CA
	WMI-2000	WMI International, Inc. Houston, TX
NUTRIENT ADDITIVES	INIPOL EAP 22 (Oleophilic)	Societe, CECA S.A. France
	LAND AND SEA RESTORATION	Land and Sea Restoration LLC San Antonio, TX
	BILGEPRO (S-200)	International Environmental Products LLC Conshohocken, PA
	OIL SPILL EATER II	Oil Spill Eater International, Corporation Dallas, TX
	VB591™ WATER VB997™ SOIL, AND BINUTRIX (partially encapsulated and oleophilic)	BioNutra Tech, Inc., Houston, TX

## CRUDE OIL CHEMISTRY

Crude oil is a complex mixture of mainly organic compounds comprised from 1 to 60 carbon atoms and hydrogen atoms (approximately 85% carbon, 15% hydrogen). The composition of crude oil depends upon the type of oil formation, the location, and the underground conditions where it is found. The majority of crude oil contains high amounts of hydrocarbons compared to the non-hydrocarbon fraction (90%:10% ratio). While carbon and hydrogen are the main elements of crude oil, sulfur (0-5%), nitrogen (0-1%) and oxygen (0-5%) are other important minor constituents. Typically, crude oil also

contains a wide variety of trace metals like nickel, iron, aluminum, vanadium, and copper. Heavy metals commonly found in land-treated refinery wastes in concentrations greater than 10 parts per million (ppm) include chromium, copper, lead, nickel, and zinc. Note that high metal concentrations may “disallow” use of OPA funds for cleanup efforts.

Generally, crude oil is distilled to separate different fractions of hydrocarbons according to their boiling point ranges. Table 1-5 presents typical crude oil fractions based on approximate carbon chain and boiling points.

**TABLE 1-5 Crude Oil Distillation Fractions**

Fraction Name	Appropriate Carbon Number Range	Boiling Range (°F)
Gas (Butane, LPG, Propane, Methane and Lighter)	C1 - C4	< 90
Gasoline (Auto Gasoline and Aviation Fuel)	C5 - C12	90 - 220
Naphtha and Jet Fuels (Jet Fuel, Solvents)	C11 - C13	220 - 315
Kerosene and Jet Fuels ( No. 1 Fuel Oil)	C10 - C13	315 - 450
Light Gas Oil (Diesel Fuel, No. 2 Fuel Oil, Home-heating Oil)	C10 - C20	450 - 650
Heavy Gas Oil (No. 4 & 5 Fuel Oil, Lubricating Oil)	C19 - C40	650 - 800
Residuals - Residual Oil (Bunker C Oil, Waxes, Asphalt, Coke)	> C40	> 800

Typically, fractions that have the lowest boiling point contain shorter-chain hydrocarbons and will biodegrade quicker and more efficiently. Other factors that influence the ability of crude oil to biodegrade are its API gravity and sulfur content. An elevated value of API gravity indicates that the oil contains a high concentration of short-chain hydrocarbons; thus it has a lower boiling point and biodegrades faster. As a rule of thumb, oils with an API gravity greater than 30 will biodegrade quite readily, and oils with an API gravity less than 20 will be very difficult to biodegrade and are probably not suitable for landfarming. API gravity is also important to know because it can be used to predict the biodegradability of the oil according to the following empirical formula:  $(2.24 \times \text{API gravity}) - 19.28 = \text{max \% Oil \& Grease biodegraded}$  (McMillen, Oct 2002).

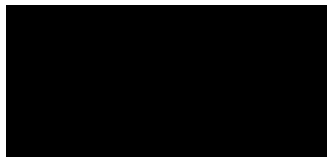

Oils that have high sulfur content are considered to be sour as opposed to oils that have a low sulfur content, which are considered sweet. The API gravity and sulfur content found in various crude oils handled in this region can be found in Appendix C.

Oil undergoes several physical, chemical, and biological changes when introduced in the environment. This change is often referred to as weathering and includes several processes: evaporation of volatiles, dissolution in water, photo-oxidation by sunlight, and of course, biological degradation. All these processes favor the weathering of oil by degrading the short-chain hydrocarbons. Therefore, oils that have sustained more weathering will be more difficult to bioremediate.

Another and, by far, the best means to characterize oils is to perform a gas chromatographic/mass spectrometric analysis of the oil. The gas chromatograph separates each constituent of the oil and forms a fingerprint spectrum, whereas, the mass spectrometer identifies each constituent. The fingerprint can be used to positively identify the type of oil present and can also provide an indication on the degree of weathering of the oil. The comparison between the fingerprint spectrum of a fresh crude oil and weathered oil is found in Appendix C.

## **SITE-SPECIFIC CLEANUP STANDARD - APPLICABLE FEDERAL AND STATE REGULATIONS**

The legislation at both federal and state level may affect the use of biodegradation technology. Existing regulations and policies that govern the use of biodegradation agents in response to spills in EPA Region 6 are summarized in the following sections.

### **Federal Regulations**

Subpart J (40 CFR Part 300.910) of the National Oil and Hazardous Substances Pollution Contingency Plan (NCP) governs the use of dispersants and other chemical and biological agents that may be used in responding to oil spills. EPA prepares and maintains the schedule, known as the NCP Product Schedule, which is updated as needed. However, the listing of a product does not constitute Government approval or endorsement of the product.

Specifically the Subpart:

- Restricts the use of chemicals and biological agents to those listed on the NCP Product Schedule (see Table 1-4).
- Specifies technical product information that must be submitted to EPA for an agent to be added to the Schedule.
- Establishes conditions for obtaining authorization to use chemical or biological agents in a response action.

The Schedule is available on the Oil Program website at <http://www.epa.gov/oilspill/ncp/>

The FOOSC, with concurrence of the EPA to the RRT as well as the RRT representative from the state with jurisdiction over the waters threatened by the spill, may authorize the use of any agent listed on the NCP Product Schedule. In addition, when practical, the FOOSC should consult with the U.S.

Department of Commerce (DOC) and U.S. Department of Interior (DOI) representatives to the RRT before making a decision to bioremediate a spill. The use of particular products under certain circumstances is approved in advance by the state, DOC, and DOI representatives to the RRT; if such pre-approval is specified in the Regional Contingency Plan, the FOSC may authorize bioremediation without consulting the RRT.

## State Regulations and Policies

Although there are no state regulations that specifically address the use of bioremediation for spill response, the American Petroleum Association proposed a total petroleum hydrocarbon (TPH) concentration of 10,000 mg/kg as a criterion for cleaning up a site. A recent study has found that level to be protective of human health. (API 2001). However, some states have established guidelines and policies that use a risk-based, site-specific approach (using parameters such as groundwater depth and proximity to residential areas) to determine adequate clean up levels.

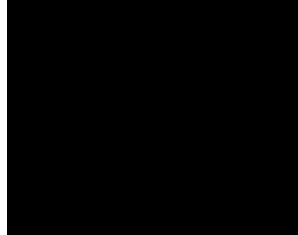

### Regulations and Policies in the State of Texas

There are no state regulations that prescribe the use of bioremediation and specify cleanup levels. However, there are legislative provisions prohibiting any activities that cause pollution of the State waters (*Texas Water Code*, Section 26.121). The Texas state agencies responsible for environmental regulations include the Texas Department of Health, Railroad Commission of Texas, Texas Commission on Environmental Quality (TCEQ), Texas Park and Wildlife Department, and General Land Office. These State agencies generally encourage the use of bioremediation for spill response when appropriate and when a physical means of cleanup are not feasible.

The TCEQ, which has jurisdiction over hazardous substances and inland oil spills, encourages bioremediation and reviews proposals to use this technology on a case-by-case basis. Under the authority of *Texas Water Code*, Section 26.264(e), the TCEQ is compiling a list of experts who can provide help during spill responses in Texas. Cleanup standards are not established for TPH due to lack of toxicity values. However, concentrations of constituents of concern, for which toxicity values have been established (e.g. benzene), should be determined and compared to health-based standards.

[http://www.tnrcc.state.tx.us/enforcement/emergency\\_response.html](http://www.tnrcc.state.tx.us/enforcement/emergency_response.html)

The General Land Office (GLO), which has jurisdiction over marine oil spills in the State of Texas, has no specific policies regarding bioremediation for spill response. The Texas Oil Spill Prevention and Response Act of 1991 authorizes the Oil Spill Oversight Council to provide advice to the GLO on bioremediation-related issues.

The Railroad Commission of Texas (RRC) has spill response authority for spills and discharges from all activities associated with the exploration, development, or production, including storage and transportation, of oil, gas, and geothermal resources. The RRC, under *Texas Administrative Code*, Title 16, Part 1, Chapter 3, rule 3.91 provides guidelines on remediation of soil.

- A final cleanup level of 1.0% by weight TPH must be achieved as soon as technically feasible, but no later than one year after the spill incident. The operator may select any technically sound method that achieves the final result.
- If on-site bioremediation or enhanced bioremediation is chosen as the remediation method, the soil to be bioremediated must be mixed with ambient or other soil to achieve a uniform mixture that is no more than 18 inches in depth and that contains no more than 5.0% by weight TPH (50 g/kg).

Furthermore, the NCP states that prior to using any chemical or biological agents to combat oil spills in water, the FOSC must obtain concurrence with TCEQ or GLO, unless the immediate use is necessary to prevent or substantially reduce a hazard to human life.

### **Regulations and Policies in the State of Louisiana**

The State of Louisiana has no regulations specifically restricting the use of bioremediation. However, Louisiana does require that selected oil spill methods be approved by the FOSC with concurrence from the Office of the Louisiana Oil Spill Coordinator. The Louisiana Oil Spill Prevention and Response Act of 1991 authorizes the Interagency Council to provide advice to the Office on bioremediation-related issues. Also, for all spills in the state, physical removal shall be the initial means of cleanup; bioremediation shall be considered only when physical means of cleanup have been exhausted or deemed unfeasible.

According to Title 43, Part XIX, Subpart 1 (Statewide Order 29B), Chapter 3, Section 313D, soil at exploration and production sites may be left without further treatment if it does not exceed the following criteria: pH between 6-9, metal concentrations within acceptable limits, and oil and grease content of soil below 1% (dry weight). Additional parameters apply in elevated, freshwater wetland areas.

### **Regulations and Policies in the State of Oklahoma**

Currently, there are no regulations for the bioremediation of oil-contaminated soil in the State of Oklahoma; however, some guidelines may be followed to aid in assessing the cleanup levels that should be achieved. Title 165 of the Oklahoma Corporation Commission, Chapter 29, discusses the remediation of petroleum storage tank sites and establishes that levels exceeding the following concentrations in native soils may require further treatment: benzene, 0.5 mg/kg; toluene 40 mg/kg; ethylbenzene 15 mg/kg; xylene, 200 mg/kg; and TPH, 50 mg/kg.

## Regulations and Policies in the State of New Mexico

Although there are no regulations for cleanup levels following bioremediation in the State of New Mexico, the Oil Conservation Division makes some recommendations about these levels. It uses a scoring system to evaluate the potential risk to public health, fresh waters, and the environment. The sum of the individual scores is added in order to determine the degree of remediation that should be achieved at a specific site. The tables below help assess the cleanup levels for benzene, BTEX, and TPH.

**TABLE 1-6 Risk assessment for evaluation of oil clean-up levels in New Mexico.**

<i>Criteria</i>		<i>Score</i>
Depth of ground water	<50 feet	20
	50-99 feet	10
	>100 feet	0
<1000 feet from water source	Yes	20
<200 feet from private domestic water source	No	10
Distance to surface water body	<200 horizontal feet	20
	200-1000 horizontal feet	10
	>1000 horizontal feet	0

**TABLE 1-7 Evaluation of clean-up action levels in New Mexico (mg/kg).**

<i>Score</i>	<i>&gt;19</i>	<i>10-19</i>	<i>0-9</i>
Benzene	10	10	10
BTEX	50	50	50
TPH	100	1000	5000

## Regulations and Policies in the State of Arkansas

The Arkansas Hazardous Waste Division does not have specific cleanup levels and follows EPA Region 6 Human Health Medium-Specific Screening Levels ([www.epa.gov/Region6/6pd/rcra\\_c/pd-n/screen.htm](http://www.epa.gov/Region6/6pd/rcra_c/pd-n/screen.htm)) for screening purposes. The majority of the sites are cleaned up to site-specific levels using a risk-based approach.

# PART II

## REMEDY SELECTION

Several options are available to clean up soil contaminated with oily wastes. The EPA guidance document *How to Evaluate Alternative Cleanup Technologies for Underground Storage Tank Sites* <http://www.epa.gov/swerust1/pubs/tums.htm> may be useful to the reader as it examines ten alternative remediation technologies.

A very important factor in the selection of the adequate remediation technology is cost. Not only does the actual treatment cost need to be evaluated, the added cost of preparatory work such as laboratory scale treatability studies or pilot-scale evaluations should be included. That preparatory work is essential to properly determine if the selected treatment will permanently and significantly reduce the concentration of contaminants in soil prior to designing and constructing the actual land treatment unit. Landfarming is not a simple chemical degradation process, it also involves biochemical processes and its applicability must be evaluated prior to conducting large scale operations in order to adjust the variables and optimize the efficiency in a minimum amount of time.

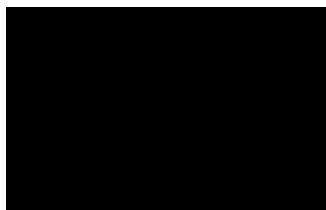

Landfarming is recommended when large land areas are available, the groundwater is deep or an impermeable barrier can be constructed, starting oil concentrations are less than 5%, and a long treatment time is not an issue (McMillen, May 2002.)



## ECONOMIC/COST BENEFIT ANALYSIS

**TABLE 2-1 Estimated cost of various treatment technologies (production only)**

Treatment technology	Cost per yd <sup>3</sup> (\$)
Washing	165-250
Landfill disposal	65-525
Thermal incineration	40-900
Solvent extraction	85-375
Encapsulation	400-650
Incineration	325-1000
<i>Natural bioremediation</i>	<i>3-50</i>
<i>Land treatment</i>	<i>40-90</i>
<i>Ex Situ treatment</i>	<i>130</i>
<i>Land treatment (bioremediation) with minimal leachate control</i>	<i>40-80</i>
<i>Land treatment (bioremediation) with extensive leachate control</i>	<i>135-270</i>
<i>Bioremediation (using microbe addition)</i>	<i>17-165</i>

One of the factors that must be considered prior to selecting bioremediation as an alternative for the treatment of contaminated soil is the cost. Although the cost per ton or cubic meter for bioremediation is often less than that of other technologies (see Table 2-1), the cost of laboratory studies and pilot tests must be included when estimating the total cost of the remediation. Treating larger amounts of soil using bioremediation will result in more economy since the cost of the studies and tests can be amortized over a larger overall cost for the project. Estimated costs for laboratory studies are between \$25,000 and \$50,000, and can vary from \$100,000 to \$500,000 for pilot tests or field studies.

The costs listed above are approximations and several factors can contribute to lowering the cost per unit. The proximity of materials needed to perform the remediation will decrease transportation costs, and if the labor for tilling and monitoring costs are amortized over a larger area, the unit cost will also decrease.

# AEROBIC BIODEGRADATION REMEDY SCREENING/ SELECTION STUDIES

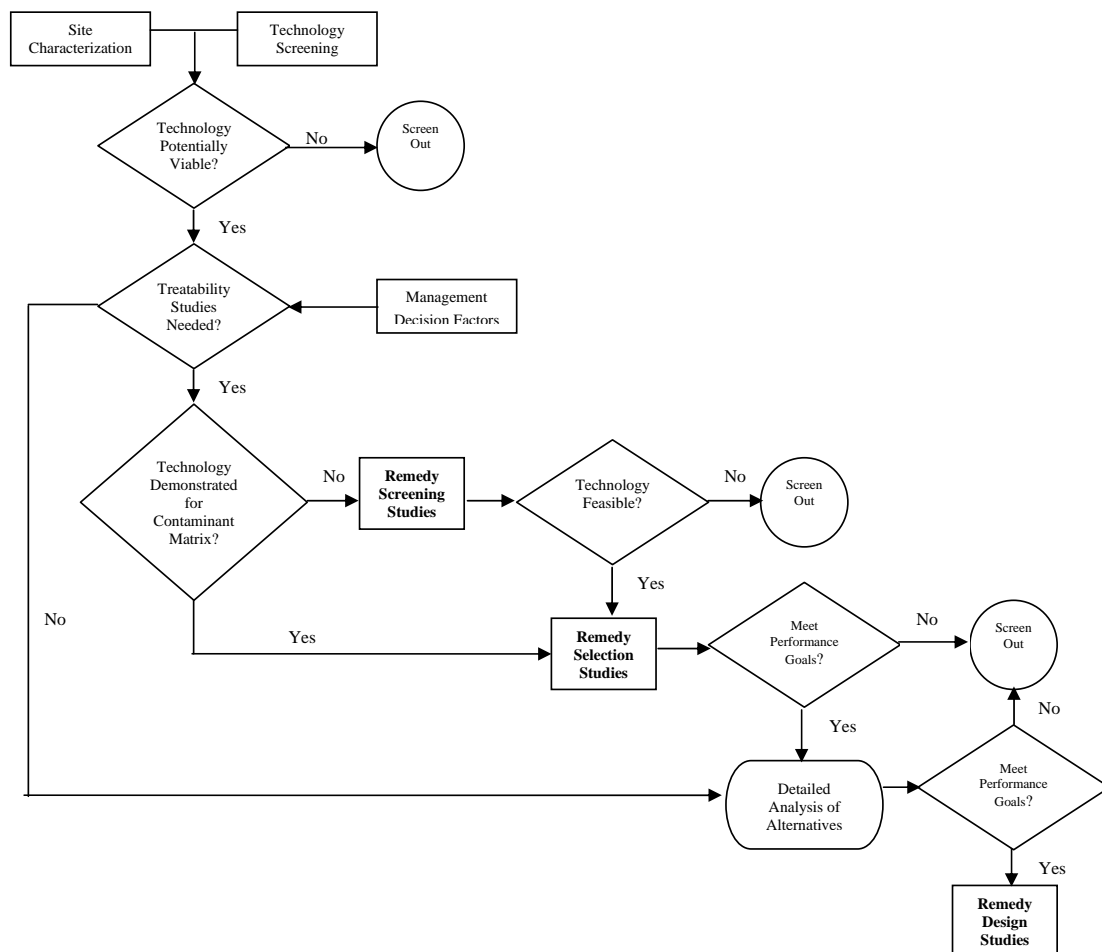

**FIGURE 2-1 Flow Diagram of Tiered Approach (EPA 540/2-91/013A)**

Remedy screening is the first level of testing, usually conducted to establish the validity of a technology to treat a waste. It is inexpensive and only requires a short period (average 4 to 6 weeks) to identify operating standards for investigations. It is a preliminary indication of a technology to meet performance goals. Typically, test reactors are used to conduct this study with different pre-determined parameter controls. The results of various test reactors are compared with a reactor with inhibited control,

which is treated with sterilization agents. Generally, a reduction of 20 to 60% (corrected for non-biological losses) in a period of 3 to 6 weeks is considered successful. This remedy screening evaluation should provide indications that the degradation is due to biological processes and not to abiotic processes such as volatilization and photodecomposition, and provide design information required for the next level of testing.

Remedy selection is the second level of testing. This phase generally requires several weeks to months to complete and the study provides data used to verify that the technology is likely to meet the cleanup goals. The test simulates field conditions and identifies potential problems that may be encountered during the full-scale project. Detailed procedures of these studies can be found in EPA guidance documents EPA/540/2-91/013A and EPA/540/R-93/519a. The studies are typically conducted for large projects and when TPH concentrations are very high, and there is potential for presence of heavy metals. A poor soil structure like clayey soils may warrant this type of study. A typical tiered approach to remedy screening, selection, and design is depicted in the flow diagram illustrated in Figure 2-1.



## Biodegradation Treatment Design

### *In-Situ* Bioremediation Treatment

If the contaminated soil medium is generally less than 12 inches and there is remote concern for groundwater contamination due to potential off-site migration, *in-situ* biodegradation should be considered to minimize material handling and to reduce costs. Perimeter berms should be constructed to control stormwater run-on and runoff. In addition, social and economical restraints and current land use must be evaluated before initiating the project to avoid any future public opposition. The FOOSC must confer with the state before initiating an *in-situ* bioremediation project.

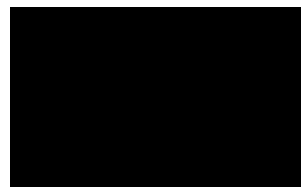

## Ex-Situ Bioremediation Treatment

### Land Treatment Unit Site Evaluation and Selection

When the contaminated soil volume is very large or hydrocarbons have penetrated deeply into soils and waste cannot be treated *in situ*, *ex-situ* bioremediation should be considered. The land treatment unit (LTU) provides a platform where soil conditions (pH, nutrient, moisture, and tilling) can be optimized to promote microbial activities. Before selecting an LTU site, many factors such as local hydrology, geology, existing topography, climate, and prevailing winds must be considered because a single overriding factor can make a site unsuitable for land farming. A brief discussion of these parameters is provided in the following paragraph; however, for a detailed consultation refer to Hazardous Waste Land Treatment, SW-874, September 1980.



Before selecting a site, indigenous soil, surface water, and groundwater hydrology should be evaluated. Highly permeable soils present high potential for groundwater contamination. Groundwater hydrology evaluation allows one to position monitoring wells up- and down-gradient of the LTU (if required by the regulations). In addition, a geological assessment will aid in proper design and operation management. Although climate has a great influence on the waste treatment process, there is no direct control on this factor, but a historical study of local climate may help determine LTU loading and estimated treatment times during hot and cold cycles. Prevailing winds dictate the location of the LTU with reference to nearby population.

### Land Treatment Unit Design and Construction

A properly engineered LTU can compensate for many limiting factors, which were discussed in the previous section. Based on site-specific conditions and state requirements, a LTU could be designed with a liner (synthetic or clay) to prevent any off-site migration of leachate generated during the waste treatment phase. Perimeter side berms should be constructed to control stormwater surface run-on and runoff. Figure 2-2 illustrates a schematic of *ex-situ* land treatment unit. An irrigation system may be installed, depending on local climate, to maintain the soil moisture content in desirable range. A leachate collection coupled with irrigation system could assist in recirculation of leachate generated from the LTU, including any storm water run-on, and eliminate the off-site disposal.

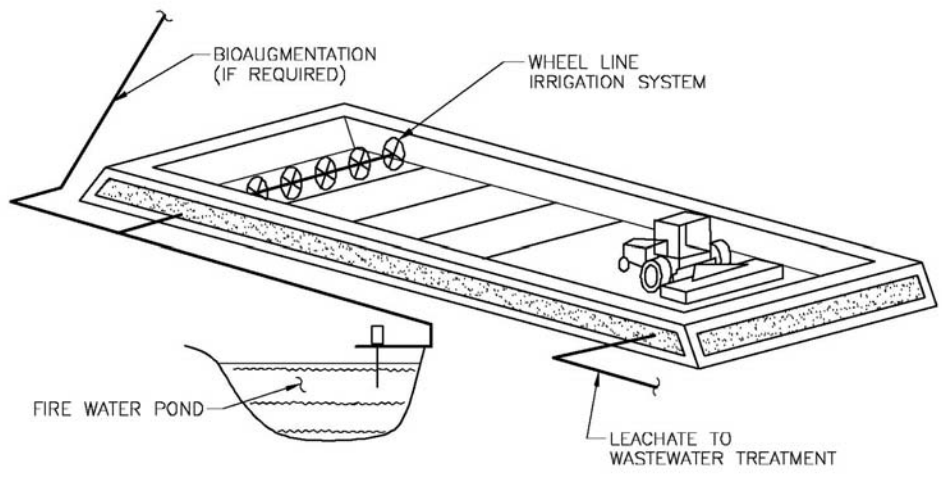

**FIGURE 2-2 Schematic of typical ex situ land treatment unit**

# PART III

## LAND TREATMENT UNIT OPERATION

Biodegradation of hydrocarbons in soil occurs naturally because of the presence of indigenous bacteria. Optimal environmental conditions can promote bacterial growth and increase LTU efficiency. This part describes the factors that can affect the rate and efficiency of the treatment.

### LTU LOADING RATES

Loading rates of the LTU depend on API gravity of the oil and the temperature of the soil. Oils with lower API gravity numbers contain heavier fractions and thus, biodegrade more slowly. Table 3-1 recommends TPH loading rates for hydrocarbons. (Deuel and Holiday, 1997)

TABLE 3-1 Initial TPH Loading Rates

Average soil temperature (°C)	% TPH, API gravity >20	% TPH, API Gravity <20
≥ 22	5	3
15-21.9	4	2
8-14.9	3	1
<8	0	0

### BIODEGRADATION TREATMENT TIME

Several factors affect the biodegradation treatment time required to attain cleanup goals. Therefore, it is a challenge to predict a timeframe for biodegrading oily wastes. Figure 3-1 illustrates that various crude oils biodegrade at different rates, making predictions difficult to achieve. Researchers have made an attempt to calculate half-lives for a specific types of crude oil or other petroleum products. Table 3-2 provides some half-life biodegradation times ( $T_{1/2}$ ) for diesel fuel and crude oil in the laboratory and in the field. Observation of this data allows one to conclude that hydrocarbon removal rates are proportional to the initial hydrocarbons concentrations.

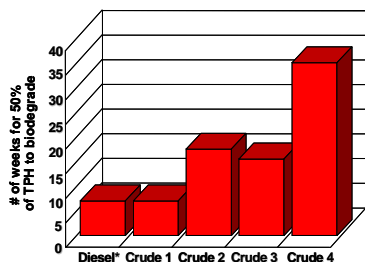

FIGURE 3-1 Half-life degradation of diesel fuel and various types of crude oils as practiced by Chevron Texaco Company. (McMillen et al, May 2002)

\* UNDER IDENTICAL ENVIRONMENTAL CONDITIONS  
Data are for a loam soil

**TABLE 3-2 Summary of Laboratory and Field Treatment Data (Sublette 2001)**

Hydrocarbon Type	Initial Concentration (mg/kg)	Final Concentration (mg/kg)	Average Rate (mg/kg/day)	T <sub>1/2</sub> (Days)
Diesel Fuel	100,000	42,000	518	50
No. 6 Diesel	60,000	24,000	400	68
Diesel Fuel	4,500	270	87	12
Diesel Fuel	1,350	100	10	70
Diesel Fuel	1,200	100	40	8
Crude Oil	15,000	6,750	56	122
Oils (Refinery)	12,980	1,273	50	71
Heavy Oil	7,900	3,000	58	60
Crude Residuals	6,000	1,000	65	38

Studies by Chevron Texaco demonstrate that there is a correlation between API gravity, Oil and Grease, and TPH percent loss that can be achieved with bioremediation over a period of time. Oils with higher API gravity, and thus with a higher content of light hydrocarbons, exhibit a higher percent loss of Oil and Grease and TPH.

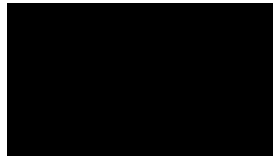

## **CONDUCTING AN EFFECTIVE BIOREMEDIATION - MONITORING LTU VARIABLES**

Soil moisture, pH, nutrients, oxygen transfer, presence of metals and toxics, and salinity are the utmost controlling factors, that must be monitored and can be optimized to achieve time-efficient biodegradation rates at a given site. Another important factor is the climate, but it is beyond the control of the responder. Figure 3-2 demonstrates many essentials to conducting an effective bioremediation of oil wastes. Desirable soil parameters ranges that should be maintained to conduct a time-efficient bioremediation in the land treatment unit are as follows: moisture content (% field capacity) 50-70%, pH 6-8, temperature 75-95°F, and nutrient ratio (C:N:P:K) 100:5:1:1. 3-3 provides a desirable optimal soil parameter. A detailed discussion on each factor is provided in the following sections of this part.

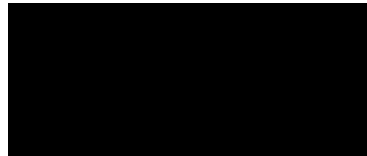

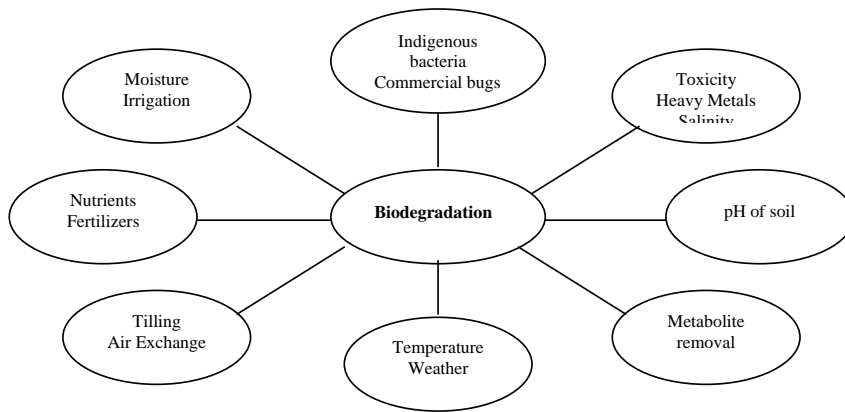

**FIGURE 3-2 Factors Requiring Assessment During Biodegradation of Oily Wastes**

### Soil Moisture Content

Soil moisture maintenance at ultimate levels is very important and is generally the most neglected area in land farming operations. Too much water or too little water can be detrimental to an aerobic bioremediation operation. Saturation will inhibit oxygen infiltration, and dry conditions will slow down the microbial activity or even stop the biodegradation process if a wilting point is reached. A desirable range is between 70 to 80% of field capacity. This will allow the bacteria to get both air and water, which are very much needed for life.

A soil is at field capacity when soil micropores are filled with water and macropores are filled with air. The water holding capacity depends upon the nature of the soil. Table 3-3 provides general soil moisture characteristics for two types of soils.

**TABLE 3-3. LTU Soil Characteristics for Effective Bioremediation Treatment**

Soil type <sup>1</sup>	Water application rate	Moisture holding capacity	Permeability	Field capacity <sup>2</sup> (~ % by weight)	Wilting point <sup>2</sup> (~ % by weight)
Sandy	10-12 inches	High	Low	9-25	3-10
Clayey <sup>3</sup>	8-9 inches	Low	High	38-43	25-28

1 For detailed soil classification, refer to Hazardous Waste Land Treatment, SW-874, September 1980.

2 Soil field capacity and wilting point are dependent upon silt and clay content. These numbers are approximate and proper evaluation should be conducted in the field.

3 Provided the moisture content is maintained at optimum levels, studies have shown that generally clay soil biodegradation rates are higher than sandy soil.



Soil moisture content should be monitored regularly and adjusted on an as needed basis to attain the desirable moisture content. For dry conditions, a fixed or moveable irrigation system may be installed. For wet conditions/high rainfall areas, underdrainage should be provided. An underdrainage system could simply be a coarse layer of material such as pea gravel overlaid by a sand layer or a state-of-the-art leachate collection system constructed at around 1% slope. This will allow the soil to drain and the leachate to be recirculated. Typically, a one-inch rain may give a combined runoff and leachate of approximately 10,000 to 27,000 gallons per acre if the LTU is maintained at the proper moisture content. A water holding pond may be necessary to hold leachate during wet conditions. This water can be used during dry conditions through an irrigation system.

## Soil Nutrients

It is known that biodegradation occurs in the absence of any treatment; however, studies have shown that careful application of fertilizers can stimulate oil biodegradation two to five-fold with no adverse environmental impact. (Prince et al).

Although potassium, sulfur, iron, and zinc are needed by microorganisms, the major nutrients limiting biodegradation are nitrogen and phosphorus. The nutrients nitrogen, phosphorus, and potassium (N, P, K) are normally added during land treatment in order to enhance microbial activities, which decompose carbon (C) compounds in the soil. Nitrogen, when added through the ammonium salts, can be toxic to microorganisms due to the possibility of generation of ammonia in the soil; the ammonium ion can also promote the increase of oxygen demand. A commonly used strategy is to add nutrients that provide a stoichiometric ratio of C:N:P:K of 100:5:1:1. However, a small-scale study by Trindate, et al evaluated the best nutrient ratios during biodegradation of crude oil-contaminated soil (5.38% TPH). They showed that when nitrogen and phosphorus were introduced in too large quantities biodegradation was inhibited. Further studies are being conducted on this topic (Venosa, personal communication).

For optimum biodegradation, nutrients can be added to the soil using organic or inorganic fertilizers, and their concentration should be closely monitored and supplemented as they are depleted during the biodegradation process. Agriculture fertilizers such as ammonium nitrate, urea, diammonium phosphate, and potassium phosphate may be added to increase nutrient concentrations in the soil. Studies have shown that urea and ammonium nitrate give superior results, and ammonium nitrate is the least expensive at 20 to 30 cents per pound. Superphosphate (0-10-0) and triple superphosphate (0-45-0) are the most common forms of phosphate fertilizers with the latter being the least expensive at 50 cents per pound. These fertilizers are usually supplied in prills and pellets and exist in the following types: water soluble (readily available); granular nutrients (slow release); and oleophilic nutrients. Compared to other nutrients, water-soluble nutrients are readily available and easier to maintain target nutrient concentrations in the soil medium. Fertilizers should be added gradually to the soil to minimize pH changes. The amount and frequency of fertilizer addition depend upon field conditions. However,

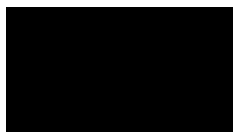

evidence from documented land farming has shown that an appropriate fertilizer dosage that could be repeated, depending upon field conditions, are 500 pounds of nitrogen per acre or 1,100 pounds of urea or 1,500 pounds of ammonium nitrate per acre and 250 pounds of phosphorus per acre. (McMillen et al, May 2002) Table 3-4 provides most commonly used agricultural inorganic fertilizers that could be used as soil nutrients.

**TABLE 3-4 Suggested Agricultural Inorganic Fertilizers**

Fertilizer	N Analysis ( % )	P <sub>2</sub> O <sub>5</sub> (P) Analysis ( % )	K <sub>2</sub> O (K) Analysis ( % )
Ammonium Nitrate	33 - 34	0	0
Urea	45 - 46	0	0
Diammonium Phosphate	18 - 21	46 - 54	0
Potassium Nitrate	13	0	44

Organic amendments like wood chips, sawdust, straw, hay, and animal manure are used to improve soil structure and oxygen infiltration, and to increase moisture holding capacity in sandy soils. In general, animal manure should be applied at the rate of about 3-4% by weight of soil and should be analyzed for nitrogen and phosphorus before its application. Bulking agents like hay, palm husks, rice hulls, and straw are added to clayey soils to increase pore space and hence, air exchange. The bulking agent should be blended into the soil until a porous structure is obtained and visual evidence of oil is eliminated. A rule of thumb to add hay in contaminated media is 5 standard hay bales per 1,000 square feet of impacted soils. The source of bulking agent may be checked and tested for residual substances (like pesticides or heavy metals) for toxicity.

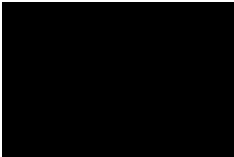

## Soil pH

Soil pH not only affects the growth of microorganisms, but also has a tremendous effect on the availability of nutrients, mobility of metals, rate of abiotic transformation of organic waste constituents, and soil structure. Usually, a pH range of 6-8 units is considered optimum for biodegradation activities.

Soil pH can be adjusted by addition of chemical reagents. For acidic soils, agriculture lime may be used to raise the pH; aluminum sulfate or ferrous sulfate or sulfur (a slow acting chemical that requires microbial activities to generate acid) may be used to lower the pH of alkaline soils.

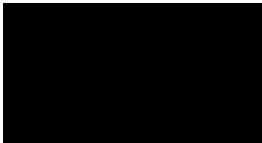

## Effect of Temperature

Biological activity is regulated by soil temperature, and an ideal temperature range is between 75 and 95°F. Since the LTU soil temperature is difficult to control under field conditions, the waste loading rates should be adjusted according to temperature (see Table 3-1.) This adjustment should also be performed during the change in season since the biodegradation rates are lower in the spring and the fall compared to summer.



## Oxygen Infiltration - Tilling

After application of waste on the LTU, tilling should be performed at regular intervals to enhance oxygen infiltration, mixing of hydrocarbons, and homogenization of soils, nutrients, and bulking agents. Tilling facilitates contact among hydrocarbons, nutrients, water, air, and microorganisms and increases biodegradation rates.

Tilling should be performed near the lower end of recommended soil moisture content and should be performed to depths up to 12 inches. Tilling very wet or saturated soil tends to destroy the soil structure, which generally reduces oxygen and water intake and reduces microbial activities. Tilling should not begin until at least 24 hours after the irrigation or a significant rainfall event. A tractor-mounted rotary tiller provides more aeration during soil mixing and is recommended for optimum results. Tilling should be conducted in all possible directions (i.e., cross length and width and diagonally to achieve maximum mixing and stirring of the LTU soils). Tilling frequency should also be considered in the operating costs of the LTU as an increased frequency will increase labor costs.



## LABORATORY METHODS FOR LTU SOIL PARAMETERS TESTING

EPA makes recommendations on LTU soil parameter testing, and a list of tests and analytical methods that can be used for quality assurance and quality control purposes can be found in Appendix D. In addition, regular monitoring using field kits should be used to amend nutrients, pH, and moisture contents of the LTU, as these tests are inexpensive and can be performed quickly.

# MONITORING HYDROCARBON BIODEGRADATION

## Baseline Soil Sampling

To ensure that the loss of hydrocarbons is due to bioremediation, a baseline concentration of hydrocarbons must first be established and biomarkers (hopanes, etc.) in the oil measured. Collecting samples for that purpose also aids in establishing a baseline for soil concentration and enables evaluation of the average petroleum loading.

Representative samples based on the LTU size should be collected and composited for TPH and GC/MS analysis. A soil sampling strategy should be followed as established in the EPA soil sampling OSWER directive in the beginning. Random soil samples collected at regular time intervals are the preferred method to assess the LTU contamination.

## Quality Assurance and Quality Control

Quality assurance and quality control should be incorporated into the bioremediation project. Use of acceptable Standard Operating Procedures (SOP) and proper data reporting format are the keys to QA/QC. Field collection of LTU samples should be conducted under the QA/QC guidelines as prepared under a Quality Assurance Sampling Plan. Nutrient, pH, microbiological and target compound analysis should be conducted according to SOP. Detailed descriptions of sampling methods and strategy can be found in Superfund Program Representative Soil Sampling Guidance OSWER 9360.4-10 directive EPA/540/R-95/141, December 1995.

[http://www.iesinet.com/useful\\_info/GuidanceDocs/1995\\_1201\\_EPA\\_SuperfundSamplingGuide.pdf](http://www.iesinet.com/useful_info/GuidanceDocs/1995_1201_EPA_SuperfundSamplingGuide.pdf)

## Interim Soil Sampling

Evidence of active biodegradation can be obtained by monitoring the following variables: consumption of oxygen, production of carbon dioxide, relative concentration of hydrocarbons relative to hopane, increases in microbial activity, production of metabolites, and consumption of nutrients. In the field, the indication that biodegradation is occurring is provided by monitoring the soil parameters at least biweekly or monthly depending on the progress and on the parameter (see Table 3-5).

**TABLE 3-5 Field methods to test LTU parameters.**



<i>Variable</i>	<i>Type of test/monitoring</i>
Moisture	Estimate using garden soil water meter OR % weight of water (see section 1.3.3.1)
Nutrients (N and P)	Field test kits (cost \$0.50 to \$20 per test), test time 5 to 30 minutes, easy to use
Oxygen and carbon dioxide	Probe
pH	Direct probe
Air and LTU temperature	Thermocouple or standard thermometer
Hydrocarbons	Gas chromatography
TPH concentration	Standard field test kits

### **Cleanup Level Confirmation Soil Sampling**

A cleanup level confirmation sampling should be performed at the completion of the treatment period and analyzed to confirm the achievement of cleanup criteria as established at the beginning of the project by EPA and the state. All biological variables should be evaluated at the termination of the study. All samples should be collected following a sampling strategy that should provide 95% confidence level for the LTU soil.

## **SITE RESTORATION**

Once the final batch of hydrocarbon-contaminated media is treated and cleanup standards are achieved, including stormwater runoff and leachate collection water quality standards, the LTU closure process should begin. The leachate collection piping including appurtenances, synthetic liner, irrigation system, and any other equipment installed during construction must be removed and disposed of or recycled as per applicable rules and regulations. The site should be graded to meet existing topography and site slope to avoid any soil erosion potential. A final permanent vegetative cover should be established, which must be a part of final closure plan. Guidance on permanent vegetative cover species can be obtained from the state agriculture or USDA departments. A good vegetative cover stabilizes the area and prevents long-term soil erosion hazards.

Assuming that the LTU is properly designed and the only liner is clay with no leachate collection system or other additional man-made construction material, the closure may be achieved by a continuation of the normal sequences of biodegradation procedures without physical removal of the liner. This will include operation and maintenance of the LTU until the clean-up levels are achieved and storm water runoff quality is acceptable. The side levees should be graded to achieve harmony with existing topography and should be followed by an establishment of permanent vegetative cover.

# BIBLIOGRAPHY

1. Arkansas Department of Environmental Quality (ADEQ) Hazardous Waste Division Regulations [[http://www.adeq.state.ar.us/hazwaste/branch\\_tech\\_admin/](http://www.adeq.state.ar.us/hazwaste/branch_tech_admin/)]
2. ASTM 1994, American Society for Testing and Materials (ASTM) ES-38-94, “Emergency Standard Guide for Risk-Based Corrective Action Applied at Petroleum Release Sites”, [<http://www.astm.org/>]
3. Banipal, B.S., Myers, J.M. ( E&E, Inc.) and Fisher, Charles (U.S. EPA) Biodegradation of Oil Refinery Wastes under OPA and CERCLA, , Superfund Conference XVI Proceedings, HMCRI, Silver Springs, MD, 1995
4. Banipal, B.S., Myers, J.M. ( E&E, Inc.) and Fisher, Charles (U.S. EPA) Biodegradation Rates of Selected Poly Cyclic Aromatic Compounds, U.S. EPA, Superfund/Haz Waste West Conference May 21-23, 1996
5. Bioremediation Engineering, Principals, Applications, and Case Studies, General Physics Corporation, 1990
6. Bioremediation Technical Support for Oil Spills, prepared for Dr. Harry Allen under REAC Contract #68-C99-223 (contract period 1-13-2000 through 5-31-2004)
7. Deuel, L. and Holiday G.H., Soil Remediation for Petroleum Extraction Industry, Soil Analytical Services, College Station, TX (1997)
8. Leffler, William L., Petroleum Refining for Non-Technical Person, Penn Well Publishing Co. 1979
9. Louisiana Department of Natural Resources, Office of Conservation, Title 43 [<http://www.dnr.state.la.us/CONS/Title43.ssi>]
10. McMillen, Sara; O’Reilly, Kirk; Bernier, Rene; Hoffman, Rob; and Smart, Ross. Bioremediation as Practiced by ChevronTexaco. Presentation at DOE/PERF Bioremediation Workshop (May 30, 2002.)
11. McMillen, Sara; Smart, Ross; and Bernier, Rene, Biotreating E&P Wastes: Lessons Learned from 1992-2002 .9th Annual Internation Petroleum Environmental Conference, Oct 2002, Albuquerque, NM. [[http://ipec.utulsa.edu/Ipec/Conf2002/mcmillen\\_smart\\_bernier\\_122.pdf](http://ipec.utulsa.edu/Ipec/Conf2002/mcmillen_smart_bernier_122.pdf)]
12. National Oil and Hazardous Substances Pollution Contingency Plan (NCP) [<http://www.epa.gov/oilspill/ncpover.htm>]
13. New Mexico Oil Conservation Division [<http://www.epa.gov/oilspill/opaover.htm>]
14. Oil Pollution Act of 1990 (OPA) [<http://www.epa.gov/oilspill/opaover.htm>]
15. Oklahoma Corporation Commission [<http://204.87.112.100/oar/codedoc02.nsf/All/3B77936100F75BEF86256CF7004F8A8E?OpenDocument>]
16. Pope, Daniel F., and J.E. Matthews. 1993. Environmental Regulations and Technology: Bioremediation Using the Land Treatment Concept. Ada, OK: U.S. Environmental Protection Agency, Environmental Research Laboratory. EPA/600/R-93/164
17. Prince, Roger C.; Clark, James R.; and Kenneth Lee; Bioremediation Effectiveness: Removing Hydrocarbons while Minimizing Environmental Impact. 9th Annual Internation Petroleum Environmental Conference, Oct 2002, Albuquerque, NM. [[http://ipec.utulsa.edu/Ipec/Conf2002/prince\\_clark\\_lee\\_109.pdf](http://ipec.utulsa.edu/Ipec/Conf2002/prince_clark_lee_109.pdf)]
18. Pritchard, P. Hap and Costa, Charles F., EPA’s Alaska Oil Spill Bioremediation Project’, final part of a five-part series by U.S. EPA, Environmental Science Technology, Volume 25, No.3, 1991

19. Railroad Commission of Texas, Administrative Code, Title 16, Part 1, Chapter 3, rule 3.91  
[<http://www.rrc.state.tx.us/rules/16ch3.html>]
20. Representative Soil Sampling Guidance, OSWER Directive 9360.4-10 EPA 540/R-95/141  
[[http://www.ert.org/media\\_resrcs/media\\_resrcs.asp](http://www.ert.org/media_resrcs/media_resrcs.asp)]
21. Risk-based methodologies for Evaluating Petroleum Hydrocarbon Impacts at Oil and Natural Gas E&P Sites, API Publication 4709, February 2001. [<http://www.api.org/groundwater/>]
22. Sublette, Kerry L., Fundamentals of Bioremediation of Hydrocarbon Contaminated Soils, the University of Tulsa, continuing engineering and science education, March 5-6, 2001.
23. Trindade, P.V.O; Sobral, L.G; Rizzo, A.C.L.; Leite, S.G.F.;Lemos, J.L.S.; Millioli, V.S.; and Soriano, A.U., Evaluation of the Biostimulation and Bioaugmentation Techniques in the Bioremediation Process of Petroleum Hydrocarbons Contaminated Soil. 9th Annual International Petroleum Environmental Conference, Oct 2002, Albuquerque, NM.  
[[http://ipec.utulsa.edu/Ipec/Conf2002/trindade\\_soriano\\_21.pdf](http://ipec.utulsa.edu/Ipec/Conf2002/trindade_soriano_21.pdf)]
24. U.S. Environmental Protection Agency OSWER Directive EPA/540/N-95/500 - No. 12, Bioremediation in the Field, August 1995  
[<http://www.epa.gov/tio/download/newsletters/bif0596.pdf>]
25. U.S. Environmental Protection Agency OSWER Directive SW-874, Hazardous Waste Land Treatment, September 1980 [<http://www.epa.gov/epaoswer/hazwaste/test/pdfs/chap12.pdf>]
26. U.S. Environmental Protection Agency Region 3 Removal Site Assessment Guidebook, published in 1991.
27. U.S. Environmental Protection Agency, Solid Waste and Emergency response Office, "Crude Oil and Natural Gas exploration and Production Wastes; Exemption from RCRA Subtitle C Regulations", EPA 530/K-95/003, May 1995
28. . Guide for Conducting Treatability Studies under CERCLA: Final. EPA/540/R-92/071a, 1992.  
[<http://www.epa.gov/superfund/action/guidance/remedy/rifs/overview.htm>]
29. U.S. Environmental Protection Agency, How to Evaluate Alternative Cleanup Technologies for Underground Storage Tank Sites: A Guide for Corrective Action Plan Reviewers. EPA 510-B-04-003 and EPA 510-B-95-007, May 1995 [<http://www.epa.gov/swrust1/pubs/tums.htm>]
30. U.S. Environmental Protection Agency. Technical Guidance Document: Construction Quality Assurance For Hazardous Waste Facilities. EPA/530-SW86-031, 1986.
31. U.S. Environmental Protection Agency. Understanding Bioremediation: A Guidebook for Citizens. EPA/540/2-91/02, 1991.  
[<http://yosemite.epa.gov/R10/EXTAFF.NSF/0/07a1f28a423390a5882565670069de05?OpenDocument>]
32. U.S. Environmental Protection Agency. Guide for Conducting Treatability Studies Under CERCLA: biodegradation Remedy Selection, OSWER Directive EPA/540/R-93/519B, August 1993 [<http://www.epa.gov/superfund/action/guidance/remedy/rifs/treat.htm>]
33. U.S. Environmental Protection Agency. Guide for Conducting Treatability Studies Under CERCLA: Aerobic Biodegradation Remedy Screening, OSWER Directive EPA/540/2-91/013A, July 1991 [<http://www.epa.gov/superfund/action/guidance/remedy/rifs/treat.htm>]
34. U.S. Environmental Protection Agency. Response Team "Inland Oil Spills" course (165.18), June 1992
35. U.S. Guide for Identifying Cleanup Alternatives at Hazardous-Waste Sites and Spills: Biological Treatment, PNL-4601/EPA-600/3-83-063
36. Venosa, Albert D., Bioremediation in Oil Spill Response, Ph.D., U.S. EPA National Risk Management Research Laboratory, Cincinnati, OH [<http://www.epa.gov/oilspill/pdfs/biofact.pdf>]
37. Waier, P.R. and K. Smit. Means Site Work & Landscape Cost Data. 11<sup>th</sup> Edition. R.S. Means Company, Inc., 1992 [<http://www.bookworkz.com/books/65283.html>]

38. Zhu, X; Venosa, A.D.; Suidan, M.T.; and Lee K.; Guidelines for the Bioremediation of Marine Shorelines and Freshwater Wetlands, US EPA Report, Sept 2001  
[\[http://www.epa.gov/oilspill/pdfs/bioremed.pdf\]](http://www.epa.gov/oilspill/pdfs/bioremed.pdf)

## **Appendix A - Typical Biodegradation Work Plan**



## SUGGESTED ELEMENTS TO BE INCLUDED IN THE WORKPLAN

- 1.0 Introduction and Objectives**
- 2.0 Site Background**  
**Site History, Site Location, General Climatology,**  
**Site Geology and Hydrogeology, Previous Sludge Analysis**
- 3.0 Rationale for Bioremediation**  
**Remedy Screening Laboratory Treatability Study, if using bioremediation agent, consult**  
**NCP Schedule**  
**Remedy Selection Pilot Bioremediation Assessment**
- 4.0 Construction of Land Treatment Unit**  
**Earthwork, Liner Installation and Leachate Collection System,**  
**Irrigation System (if required)**
- 6.0 Health and Safety**
- 7.0 Bioremediation Operations**  
**pH, Nutrients, Bacterial monitoring**
- 8.0 Soil Sampling and Analysis**  
**Removal Criteria, Soil Sampling - Initial Characterization,**  
**Interim Monitoring and Confirmation Sampling,**  
**Sample Analysis and Quality Assurance/Quality Control**
- 9.0 Material Handling Operations**  
**Excavation of contaminated soils, Loading of the Land Treatment Units,**  
**If *ex-situ*, Tilling of the Treated Soil, Unloading and Reloading of the Land Treatment Unit**
- 10.0 References**
- 11.0 Appendices**

Formatted

## **Appendix B - Useful Conversion Factors**

1. Concentration Conversions

<b>parts per million (ppm)</b>	=	<b>mg/L</b>	=	<b>mg/kg</b>
<b>10,000 ppm</b>	=		=	<b>1 %</b>
<b>ppm hydrocarbon in soil x 0.002</b>	=		=	<b>lbs of hydrocarbons per ton of contaminated soil</b>

2. Sludge Conversions

<b>1,700 lbs wet sludge</b>	=	<b>1 yd<sup>3</sup> wet sludge</b>
<b>yd<sup>3</sup> sludge</b>	=	<b>Wet tons / 0.85</b>
<b>Wet tons sludge x 240</b>	=	<b>gallons sludge</b>
<b>Wet ton sludge x % dry solids/100</b>	=	<b>dry tons sludge</b>

3. Other Conversions

<b>1 yd<sup>3</sup></b>	=	<b>27 ft<sup>3</sup></b>	
<b>1 gallon water</b>	=	<b>8.34 lbs</b>	
<b>1 lb</b>	=	<b>0.454 kg</b>	
<b>1 ton (English)</b>	=	<b>2,000 lbs</b>	
<b>1 yd<sup>3</sup></b>	=	<b>0.765 m<sup>3</sup></b>	
<b>1 acre</b>	=	<b>43,560 ft<sup>2</sup></b>	= <b>4,840 yd<sup>2</sup></b>
<b>1 acre-inch of liquid</b>	=	<b>27,150 gallons</b>	= <b>3.630 ft<sup>3</sup></b>
<b>1 ton (metric)</b>	=	<b>2,025 lbs</b>	= <b>1,000 kg</b>

4. Nutrient Conversion Factor from off the Shelves

<b>lbs P x 2.3</b>	=	<b>lbs P<sub>2</sub>O<sub>5</sub></b>
<b>lbs K x 1.2</b>	=	<b>lbs K<sub>2</sub>O</b>

5. Other Useful Approximations (not for precise calculations)

<b>1 ft depth in 1 acre (in-situ)</b>	=	<b>1,613 x (20 to 25 % excavation factor) = ~2,000 yd<sup>3</sup></b>
<b>1 yd<sup>3</sup> (clayey soils-excavated)</b>	=	<b>~1.1 to 1.2 tons (English)</b>
<b>1 yd<sup>3</sup> (sandy soils-excavated)</b>	=	<b>~1.2 to 1.3 tons (English)</b>

6. Temperature Conversions

<b>(<sup>0</sup> C x 1.8) + 32</b>	=	<b><sup>0</sup> F</b>
<b>(<sup>0</sup> F - 32) x 0.555</b>	=	<b><sup>0</sup> C</b>

## **Appendix C - Crude Oil Chemistry**

Crude oil and petroleum products consist of a complex mixture of thousands of compounds, and the composition of crude oil depends on its source. Oils exhibit a wide range of physical properties, and databases containing that information can be found on the internet or at sites such as [http://www.etcentre.org/databases/spills\\_e.html](http://www.etcentre.org/databases/spills_e.html).

The hydrocarbons in crude oil have different boiling points, according to the number of carbon atoms their molecules contain and how they are arranged. Fractional distillation uses the difference in boiling point to separate the hydrocarbons in crude oil.

The petroleum components can be classified in four groups: saturated hydrocarbons, aromatic hydrocarbons, resins, and asphaltenes. Lighter oils contain a larger proportion of saturated and aromatic hydrocarbons, whereas heavier oils contain a higher percentage of asphaltenes. Physical properties of oil affect its behavior in the environment. The following are evaluated when characterizing oils:

- Specific gravity: ratio of a mass of oil compared to the mass of the same volume of water, at a specific temperature. The lower the specific gravity, the lighter the oil is on water.
- API gravity ( $^{\circ}$ ):  $(141.5/\text{specific gravity @ } 16^{\circ}\text{C}) - 131.5$
- Viscosity: resistance to change in shape or movement. The lower the viscosity, the easier the oil flows and spreads.
- Pour point: temperature at which the oil becomes semi-solid and stops flowing.
- Solubility in water: typically, oil is not very soluble in water (30 mg/L). Solubility depends on temperature, and the most soluble components of oil are typically aromatic hydrocarbons such as the lower molecular weight monocyclic aromatic hydrocarbons such as benzene, toluene, and xylenes and low molecular weight polycyclic aromatic hydrocarbons such as naphthalene.
- Flash point: lowest temperature at which a flammable liquid produces enough vapors to ignite in the presence of a source of ignition; a low flash point indicates a highly flammable liquid.
- Vapor pressure: indication of the evaporation rate of a substance, a high vapor pressure indicates a high propensity to evaporate

Almost half of the crude oil produced in the United States is generated in Region 6 and over 42 types of crude oils are handled in the Region 6 states. The following tables list API gravity and sulfur contents found in various crude oils.

<b>TABLE C-1 Crude Oils Handled Near Cushing, Oklahoma</b>				
<b>State</b>	<b>Location</b>	<b>Crude Oil Name</b>	<b>Approximate API Gravity</b>	<b>Sulfur %</b>
OK	Cushing	Common Stream (pipeline)	37 -42	< 0.42
	Oklahoma Domestic Sweet	Cushing (lease crude)	43	0.37
		Kingfisher (lease crude)	41	0.12
		Seminole (lease crude)	38	0.33
		Osage (lease crude)	34	0.21
TX	East Texas	Lease Crude	36	0.23
	West Texas	Abilene (sweet) (Intermediate)	37	0.27
		Ozona (sour)	23	1.99
AR	Arkansas	USA Midcont. (sweet)	40	0.4
LA	Louisiana	Light (sweet)	36	0.45
		South	33	0.28
NM	New Mexico	USA West Texas (sour)	34	1.64
		Mixed Intermediate	38	0.17
		Mixed Light	43	0.07

Note: The API values provided in this table are approximate and were rounded off since there may be variations depending on when and where the sample was collected.

**TABLE C-2 Typical Crude Oils Handled In Region 6**

S.N.	Crude Oil Name	API Gravity	Sulfur %
1	Domestic Sweet	37 - 42	<0.42
2	Brass River	43.5	0.07
3	Fortles	39.5	0.32
4	Cusian	38.5	0.30
5	Olmecca	38.3	0.95
6	Brent	38.0	0.38
7	AXL	37.7	1.20
8	Qua	36.7	0.18
9	Sbar	36.4	0.56
10	Osberg	36.0	0.25
11	Bryan Mound	35.9	0.33
12	Bonny Light	35.2	0.18
13	Kirkuk	33.7	2.14
14	Basrah	33.5	2.10
15	West Texas Sour	33.5	1.78
16	ABL	32.5	1.85
17	Isthmus	32.5	1.32
18	Rabi	33.5	0.07
19	Lagocinco	32.0	1.20
20	Vasconi	30.8	0.95
21	Mesa	30.3	0.98
22	KLT	29.5	N/A
23	Djeno	27.6	0.23
24	Cano	29.4	0.55
25	Guafita	29.1	0.65
26	ABM	28.9	2.31
27	Furriel	28.5	1.05
28	Oriente	27.5	1.48
29	W.C. Sou	27.5	N/A
30	ABH	27.4	2.70
31	ANS	27.5	1.11
32	Velma	26.4	N/A
33	Mesa-25	25.9	1.43
34	OLB	24.4	1.55
35	Rata	24.2	4.00
36	Suni	24.0	N/A
37	AMB	23.5	N/A
38	Bacquero	22.8	1.95
39	Lagotraco	22.8	1.34
40	Leona	22.6	1.53
41	Maya	22.5	2.95
42	Mariago	22.1	2.85

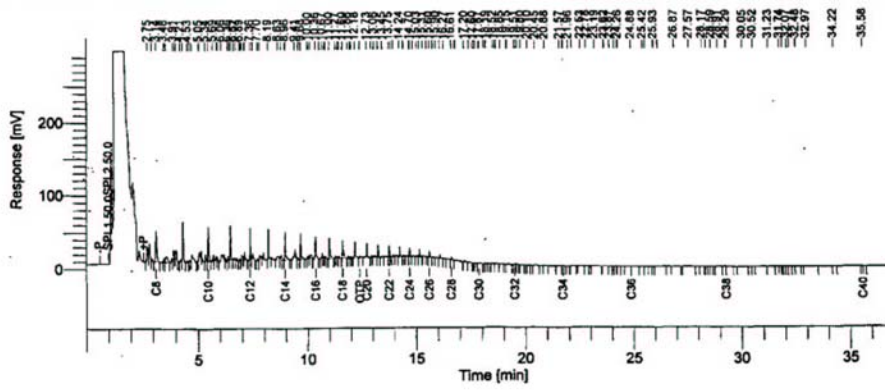

**TPH AS DIESEL BY GC/FID 8015B**  
 Gas Chromatograph/Mass Spectrum (GC/MS) of Fresh Diesel

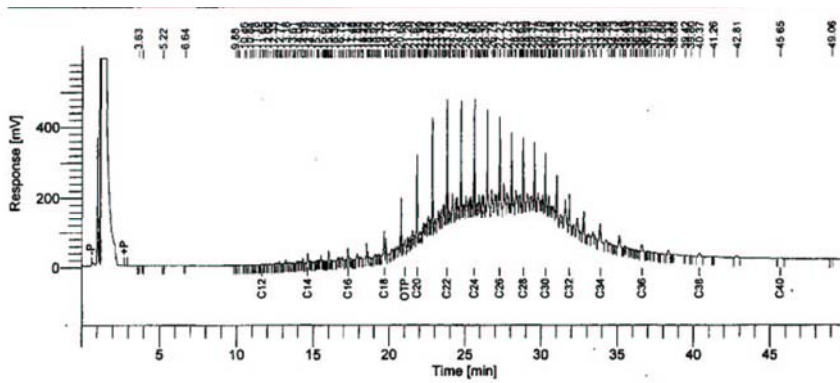

**TPH AS DIESEL BY GC/FID 8015B**  
 Gas Chromatograph/Mass Spectrum (GC/MS) of Weathered Diesel

Source: The Analytical Services Center of Ecology and Environment Inc., 2003



## **Appendix D - LTU Parameter Analysis Methods**

<b>Soil Parameter</b>	<b>Analytical Method</b>
Moisture	EPA 160.3
pH	SW 846 - 9045
Cation Exchange Capacity	SW 846 - 9081
Water Holding Capacity	ASTM 2980
Soil Grain Size	ASTM D422-63
Total Organic Carbon	SW 846 - 9060
Nitrogen Ammonia	EPA 350.1 / 350.3
Total Kjeldahl Nitrogen	EPA 351.2 / 351.3
Total Phosphorus	EPA 365.1 / 365.2
Nitrate/Nitrogen	EPA 353.2